

trendy i inspiracje wnętrzarskie
interior trends and inspirations

TRENDBOOK

2 0 2 2 | / 2 3

Szanowni Państwo,

miło nam zaprezentować **TrendBook 2022/2023**, który jest wynikiem naszego ponad 30-letniego doświadczenia w projektowaniu i wdrażaniu dekoracyjnych akcesoriów meblowych i drzwiowych. Jest także owocem naszej wieloletniej współpracy z wieloma projektantami mebli, drzwi oraz architektami wnętrz.

TrendBook 2022/2023 jest kompleksową odpowiedzią na potrzeby osób, które do urządzania swoich wnętrz podchodzą w bardziej świadomy i przemyślany sposób. Poszukują inspiracji, wskazówek i produktów, by odnaleźć idealnie dobrany do swoich potrzeb styl otaczającej ich przestrzeni.

TrendBook 2022/2023 jest pewnego rodzaju przewodnikiem, który przeniesie Państwa do ciekawych i różnorodnych wnętrz, stylistycznie nawiązujących do najbardziej aktualnych trendów w projektowaniu. Zawiera on wiele inspirujących propozycji aranżacji przestrzeni domowych i biurowych oraz prezentuje ciekawe rozwiązania wnętrzarskie dostosowane do różnych gustów, warunków oraz stylów życia. Z przyjemnością prezentujemy Państwu nasze produkty wpisujące się w stylistykę poszczególnych trendów.

Niektóre przedstawione aranżacje stawiają na prostotę i przytulny charakter pomieszczenia, inne skupiają się bardziej na funkcjonalności oraz harmonii. Nie zabrakło również inspiracji dla osób ceniących luksus i eleganckie wykończenia. Są tu także ciekawe propozycje pomieszczeń dostosowanych do potrzeb zarówno tych starszych, jak i młodszych dzieci.

Zainspiruj się i zaprojektuj swoją przestrzeń razem z nami!

Dear Sir/Madam,

We are pleased to present **TrendBook 2022/2023**, which stems from our experience of more than 30 years in decorative furniture and door accessories designing and implementation. It is also a fruit of many years of our cooperation with various furniture and door designers and interior architects.

TrendBook 2022/2023 is a comprehensive response to the expectations of people who take a more discerning and thoughtful approach when decorating and arranging their interiors and who search for inspirations, tips and products to find a style for the space around them which would perfectly match their needs.

TrendBook 2022/2023 is a guide of a kind that will transfer you to interesting and diverse interiors whose style alludes to the most recent trends in design. It embraces numerous inspiring proposals for arranging home and office spaces and presents attractive interior design solutions suitable for varying tastes, conditions and lifestyles. It is with great pleasure that we present you with our products that fit into the style of individual trends.

While some of the arrangements we present focus on simplicity and cosiness of premises, other are more about functionality and harmony. There are alluring inspirations for individuals who value luxury and elegant finishes as well as compelling ideas for interiors adapted to the needs of both older and younger children.

Get inspired and design your space with us!





4
Parisian
Modern



8
Modern
Art Déco

12
Classic



16
Scandi



20
Soft Loft



24
Industrial

28
Teens



32
Kids



PARISIAN MODERN

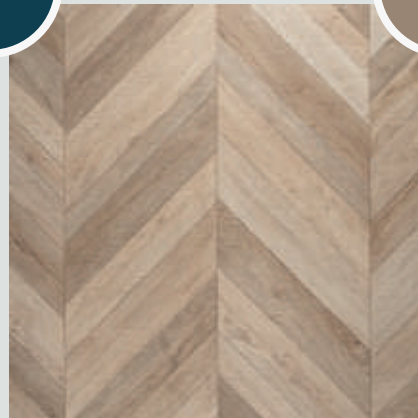
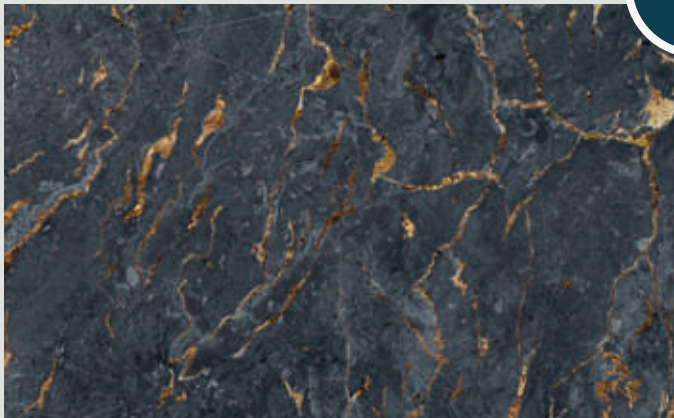

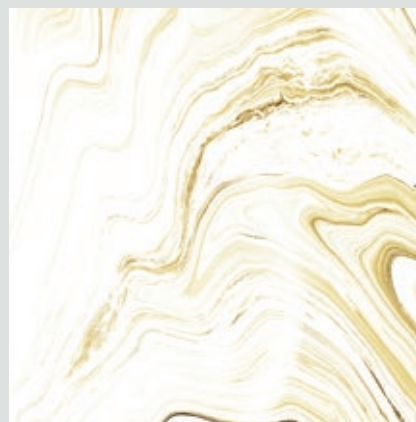
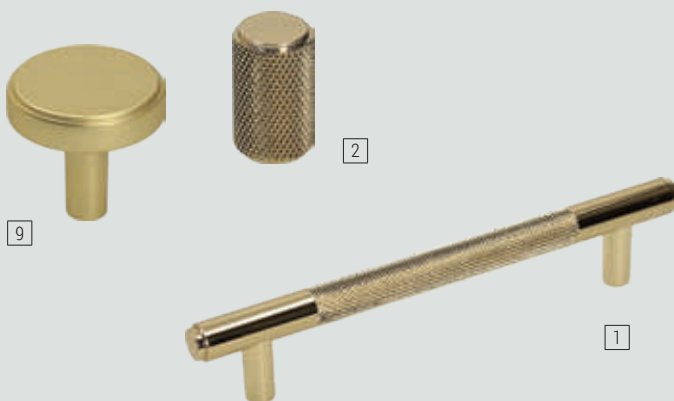

PL: Styl **PARISIAN MODERN** to połączenie klasyki z nowoczesnością. Jest on synonimem luksusu, gdzie naturalne drewno współgra z marmurem i miękkimi tkaninami. Wyróżnia go charakterystyczna sztukateria ścienna połączona ze stylowymi złotymi lub srebrnymi dodatkami. Są to wnętrza eleganckie, pełne dobrego smaku.

EN: The **PARISIAN MODERN** style is a combination of classics and modernity. It is synonymous with luxury, where natural wood harmonizes with marble and soft fabrics. It is distinguished by a distinctive stuccowork on walls combined with stylish gold or silver additions. These are elegant interiors, full of fine taste.

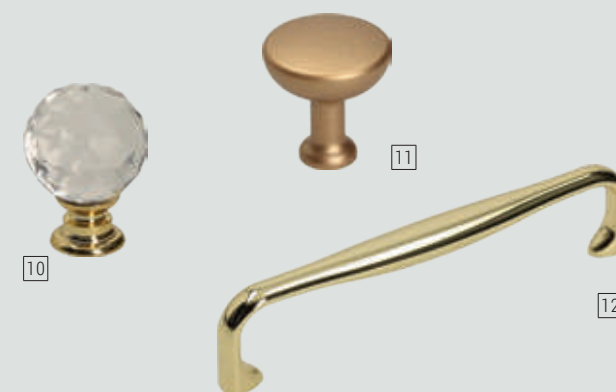
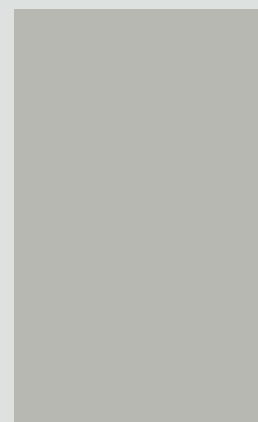

PARISIAN MODERN



13

14



15



16

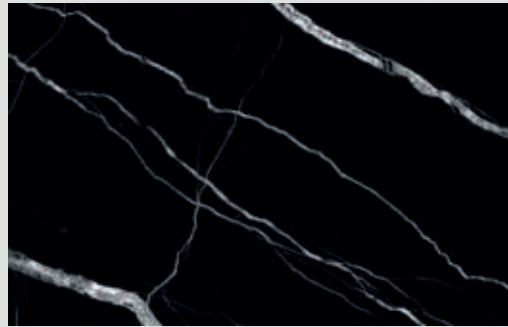

17

18

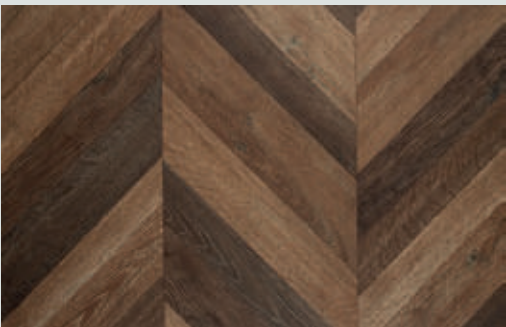

19



20





21



22



23



24



25



26

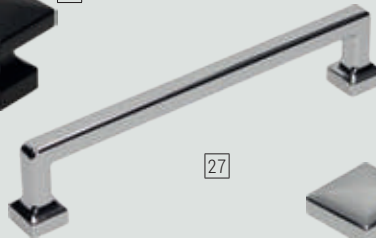

27

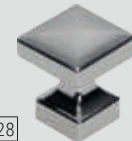

28



MODERN ART DÉCO

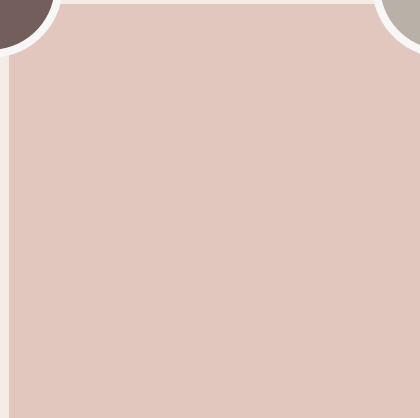
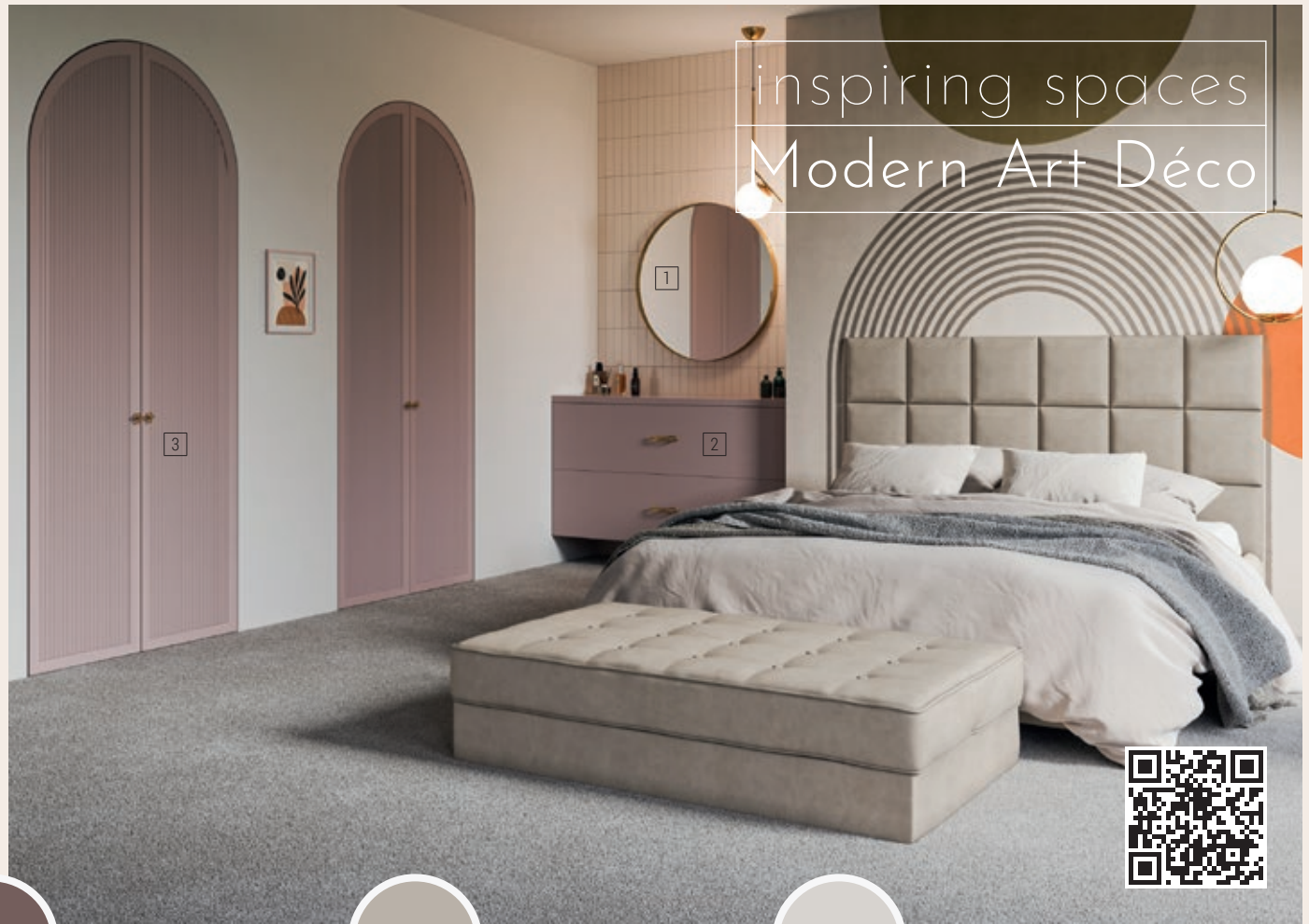

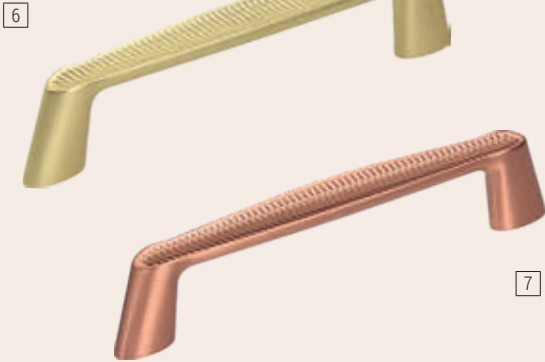
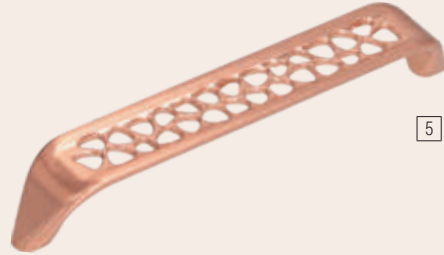

PL: Styl **MODERN ART DÉCO** to współczesna interpretacja elitarnego niegdyś stylu art déco. Cechuje go niezwykła łagodność, świetlistość i przyjemne pastelowe kolory z pogranicza beżu, szarości i różu, które często przełamane są złotymi i miedzianymi dodatkami. Geometryczne kształty porządkują wnętrza pełne eleganckich detali.

EN: The **MODERN ART DÉCO** style is a contemporary interpretation of the once elite Art Déco style. It is characterized by extraordinary gentleness, luminosity and pleasant pastel colours bordering on beige, grey and pink often interwoven with gold and copper additions. Geometric shapes neatly align the interiors full of elegant details.

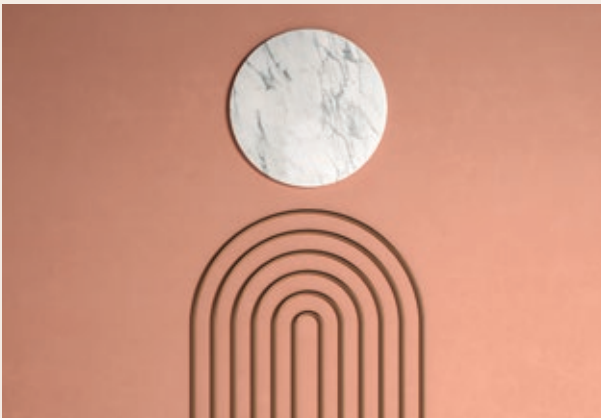

MODERN ART DÉCO



10



11

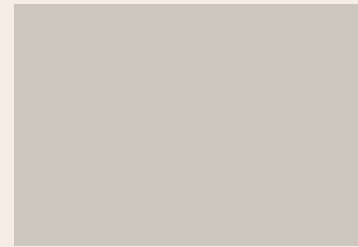

12



13

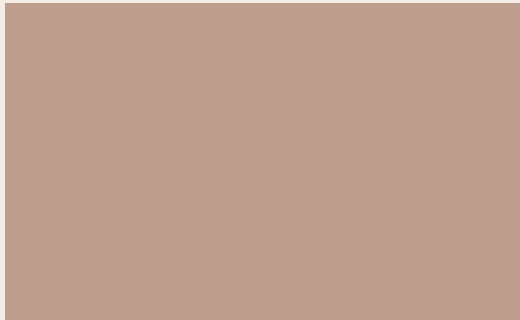

14

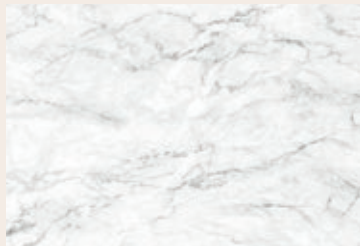

16



15



17



18



19



20



21

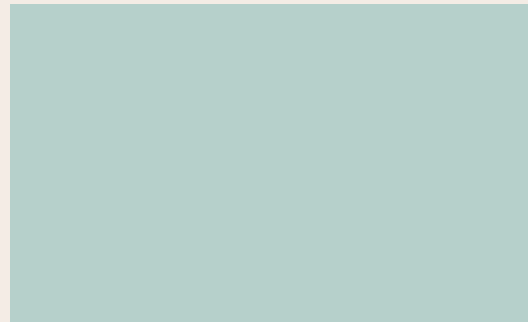

22



24



23



25

CLASSIC

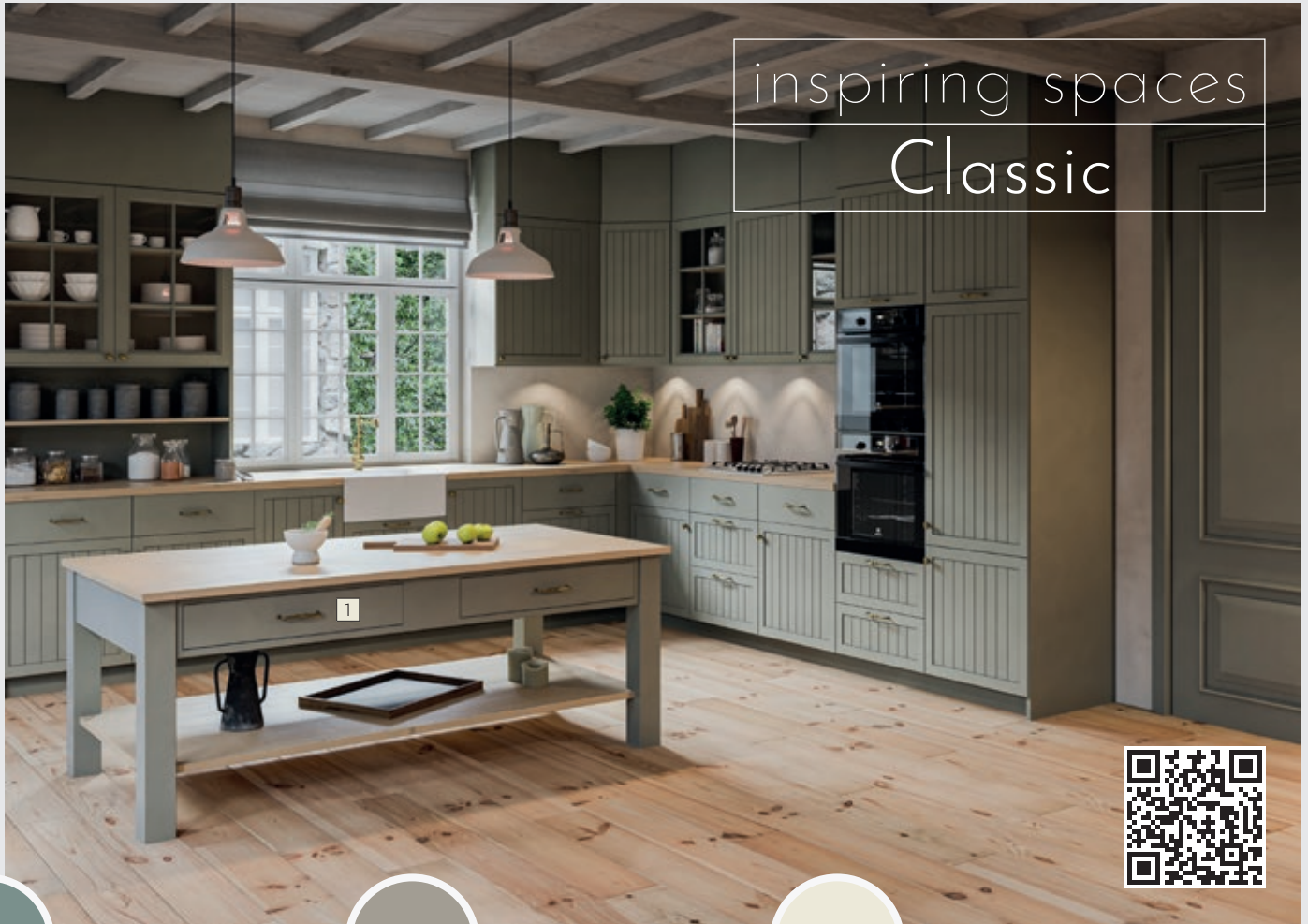

inspiring spaces
Classic

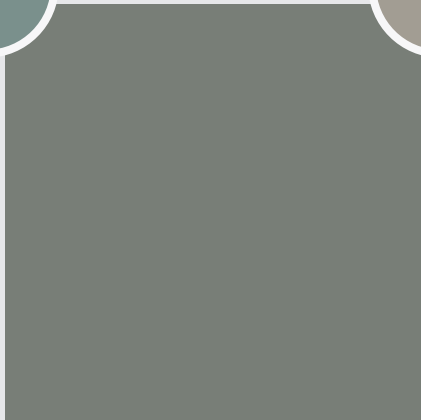

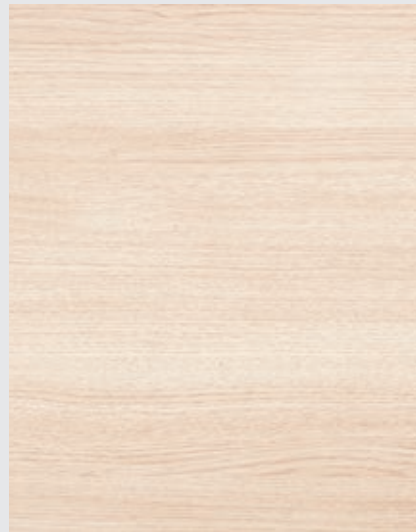

PL: Styl **CLASSIC** to esencja tradycyjnego wnętrza nawiązującego do rustykalnego klimatu. Dominują tutaj ciepłe kolory drewna, przełamane biele i ciepłe szarości oraz miękkie tkaniny z roślinnymi motywami. Ważne są dodatki z naturalnych materiałów: drewna, porcelany, ceramiki czy też wikliny. Razem to wszystko tworzy niezwykle przytulną i przyjazną atmosferę wnętrza.

EN: The **CLASSIC** style is the essence of a traditional interior with a rustic touch. Warm wood colours, broken white and warm grey shades, as well as fabrics with floral motifs predominate. Significant role is given to accessories made from natural materials such as wood, porcelain, ceramics or wicker. Combined, all this makes up the exceptionally cosy and receptive atmosphere of the interior.

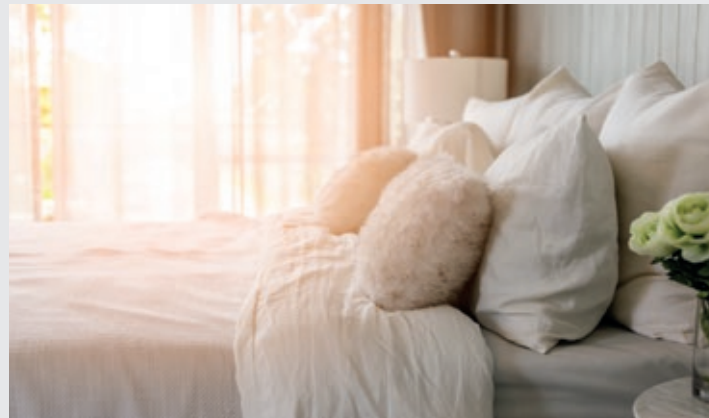

CLASSIC

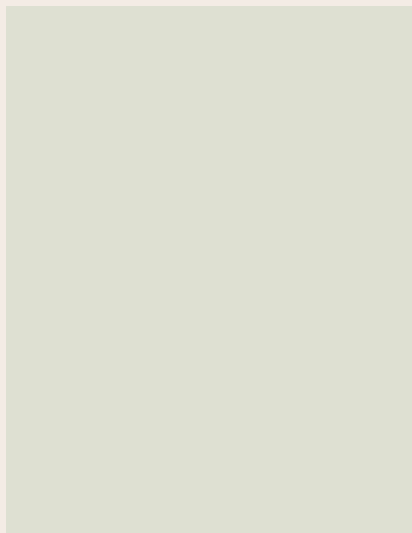
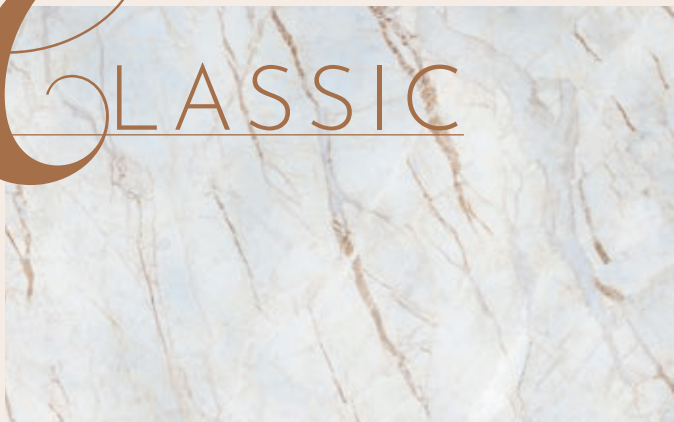

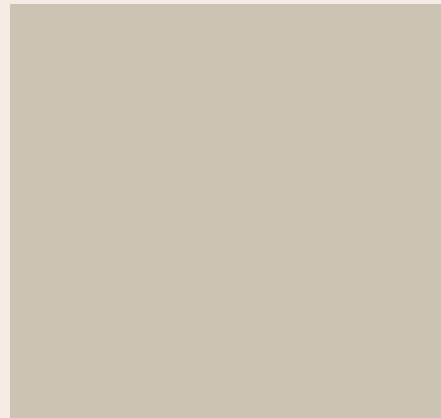
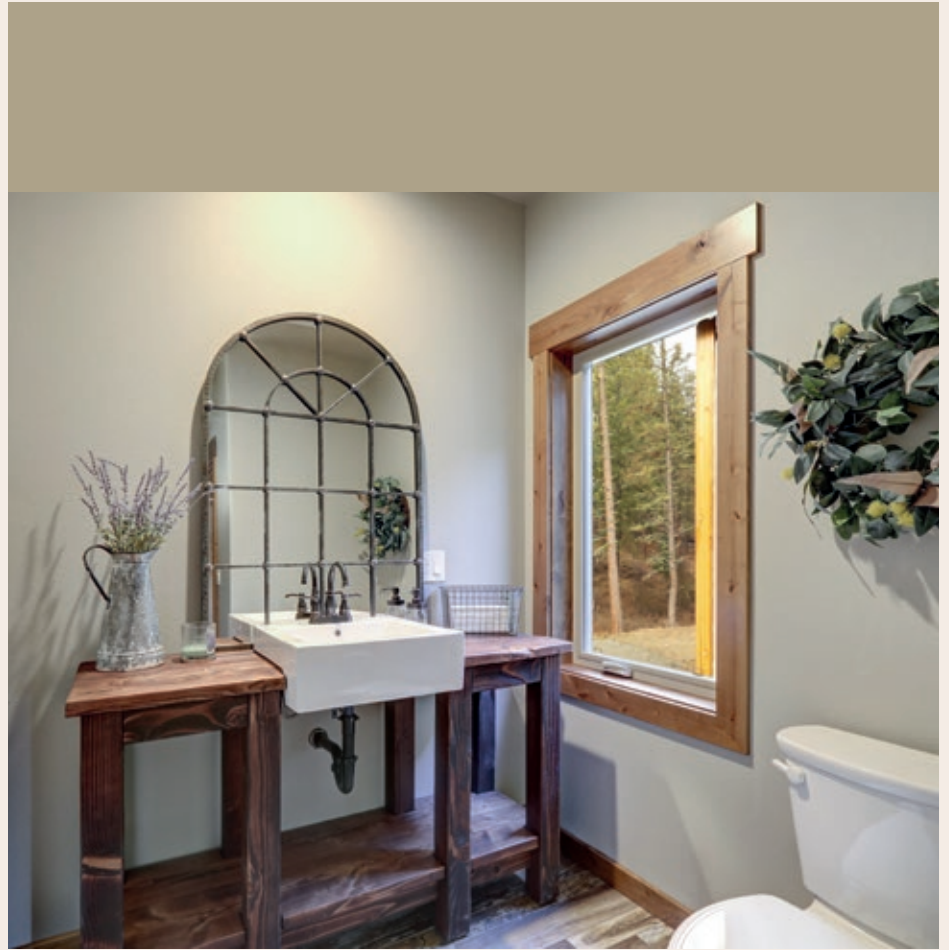

SCANDI

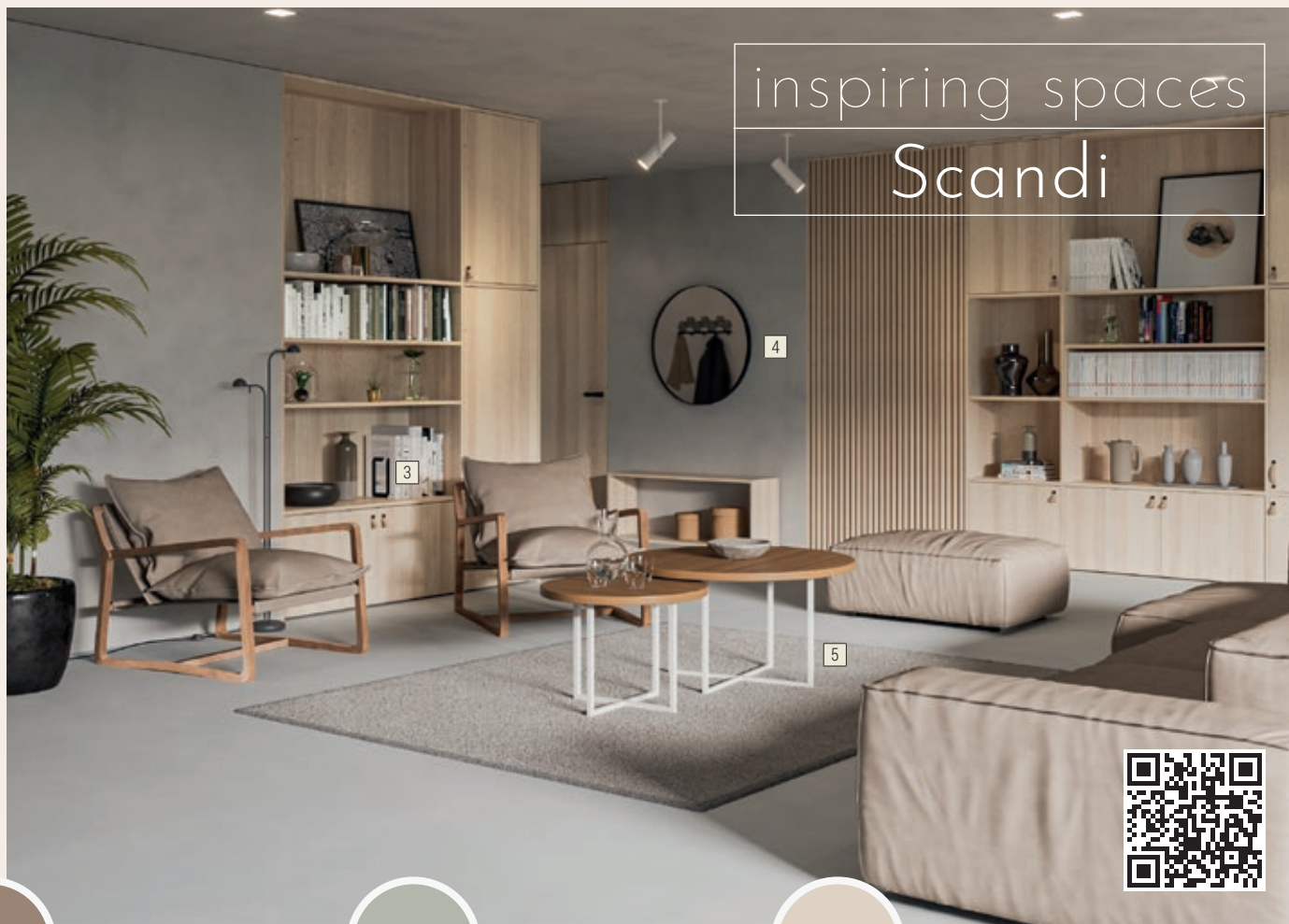

inspiring spaces
Scandi



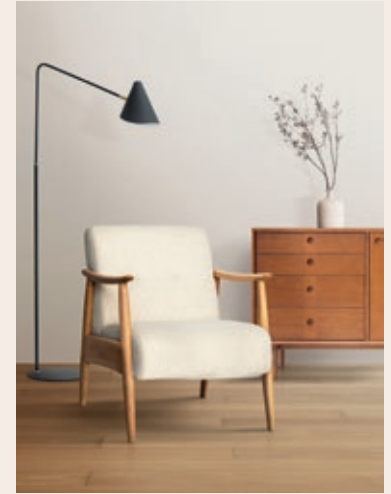
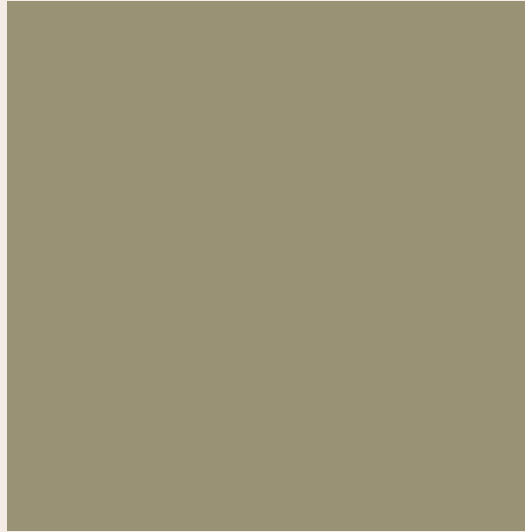

PL: Styl **SCANDI** to minimalistyczne wnętrza, w których wprost czuć obecność natury. Naturalne surowce: drewno, kamień czy też marmur podkreślają skandynawską prostotę i harmonię. Dominują w nim jasne i ciepłe tony, przełamane szarobeżowymi i czarnymi akcentami.

EN: The **SCANDI** style is minimalist interiors within which you can directly sense the presence of nature. Natural raw materials such as wood, stone or marble emphasize Scandinavian simplicity and harmony. It is dominated by bright and warm tones, broken by grey-beige and black features.

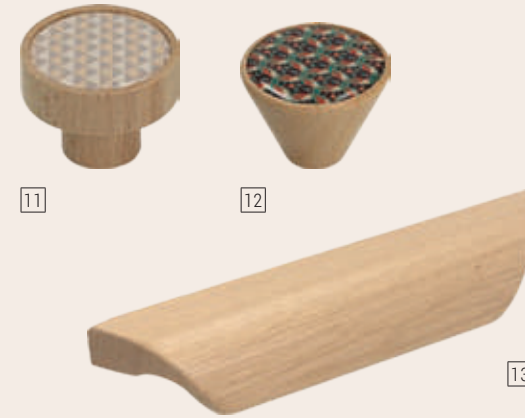
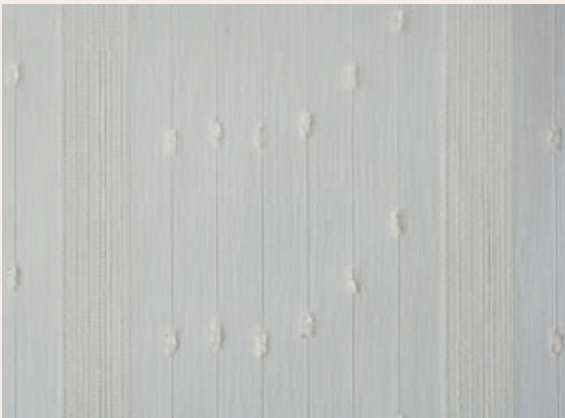

SCANDI



14



15



16



17



18



19



20



21

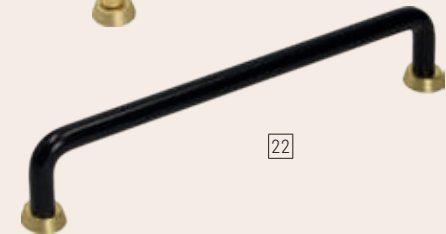

22



23

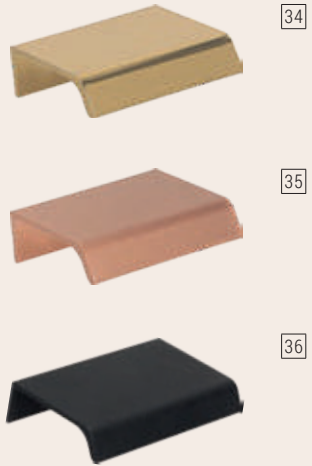

SOFT LOFT

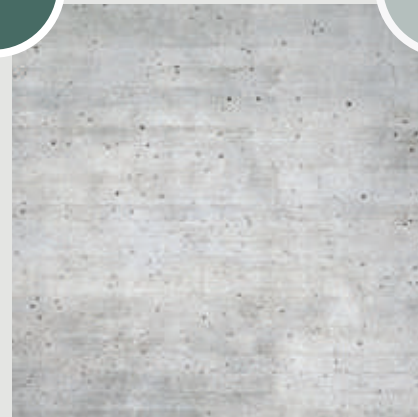
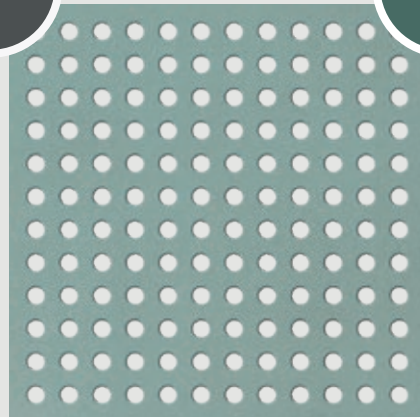
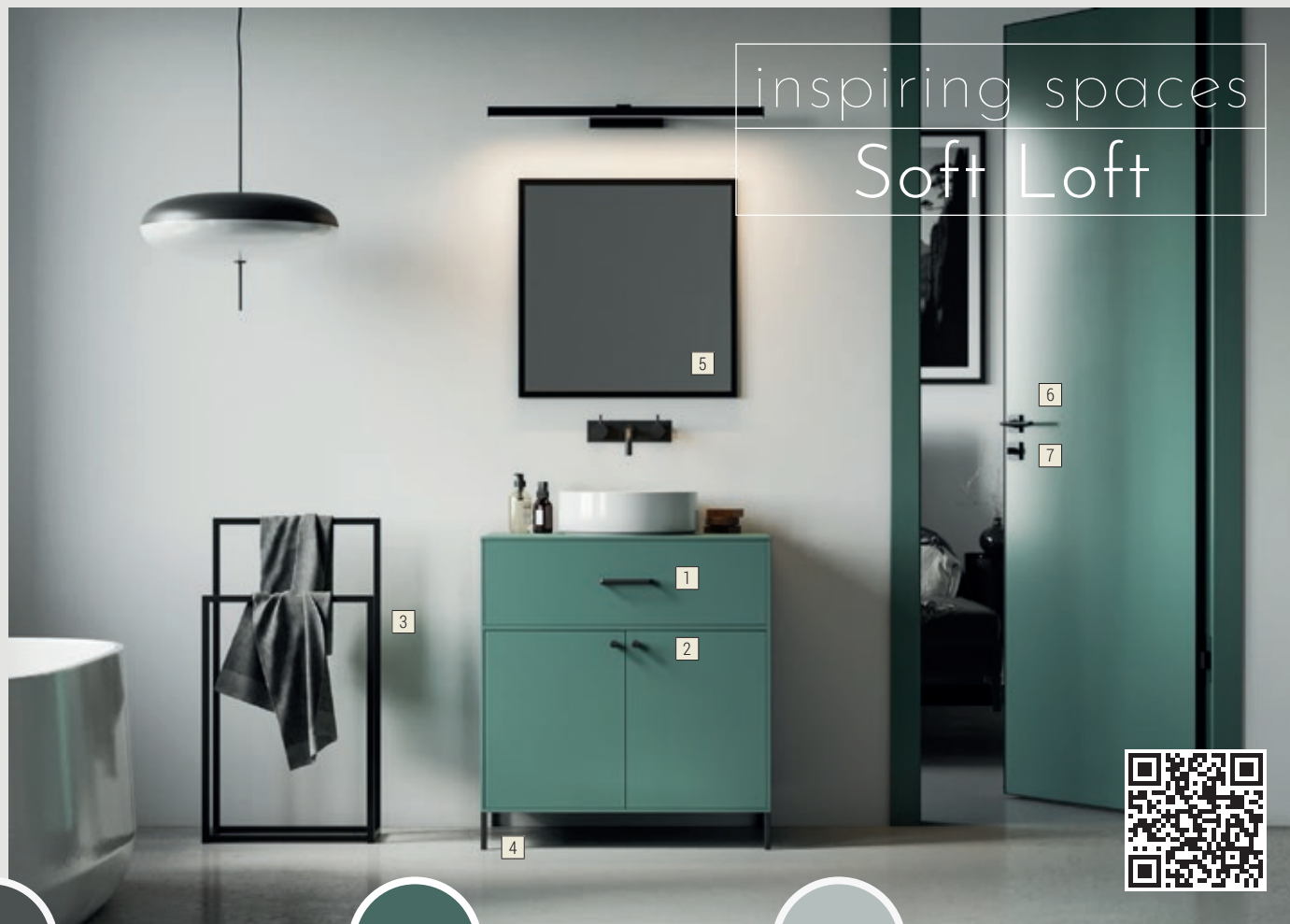
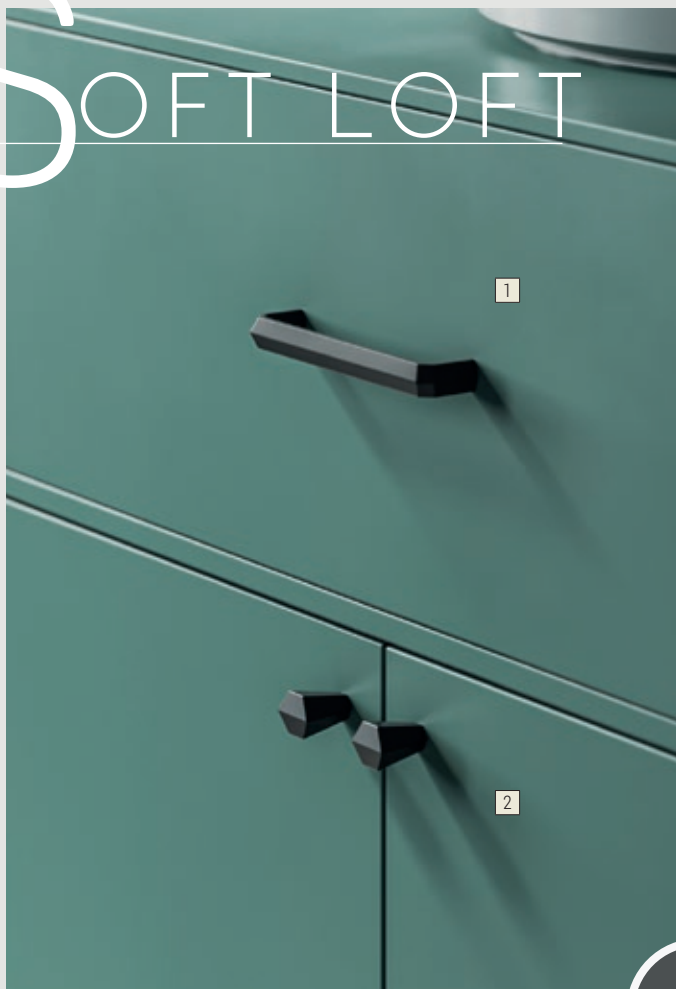

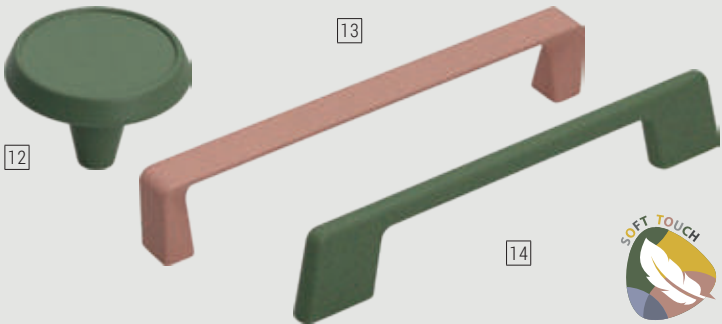

PL: Styl **SOFT LOFT** znajdujemy w nastrojowych wnętrzach z charakterystycznymi elementami, które nawiązują do stylu loftowego. Loftowa surowość znika, pojawiają się stonowane kolory, symetryczne i geometryczne wzory, które z metalowymi elementami wyposażenia wnętrz tworzą spójność całość.

EN: The **SOFT LOFT** style can be found in intimate interiors with distinguishable elements referring to the loft style. The loft austerity disappears, replaced by subdued colours combined with symmetrical and geometric patterns creating a coherent whole with interior design elements made of metal.

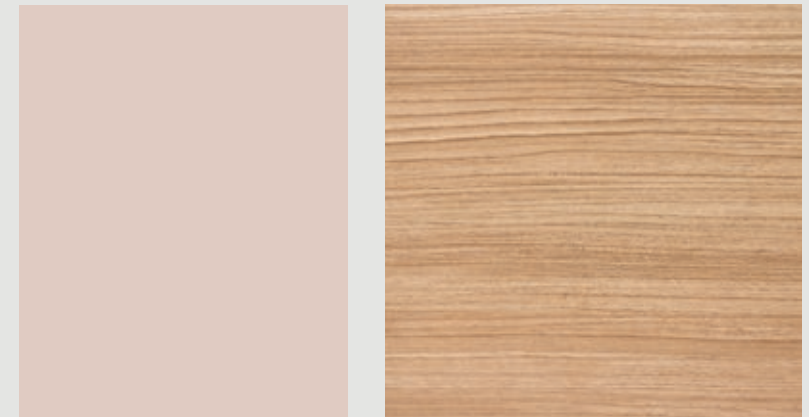

SOFT LOFT

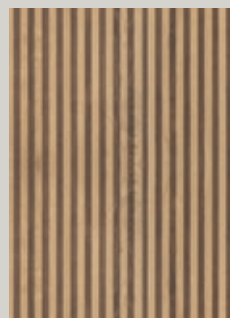
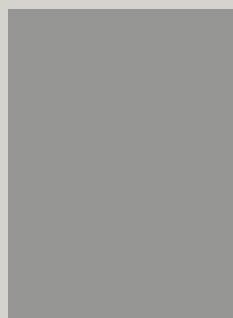
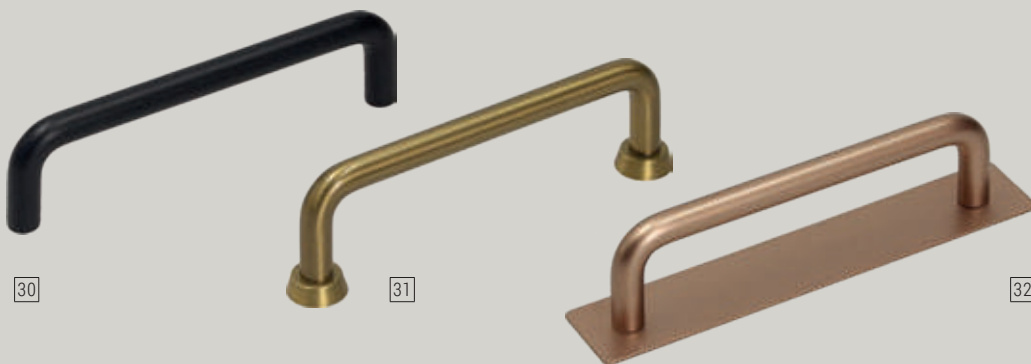
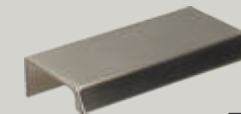
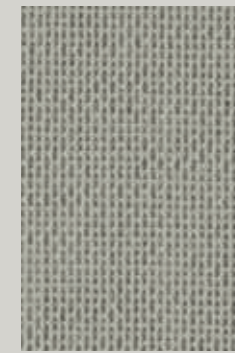

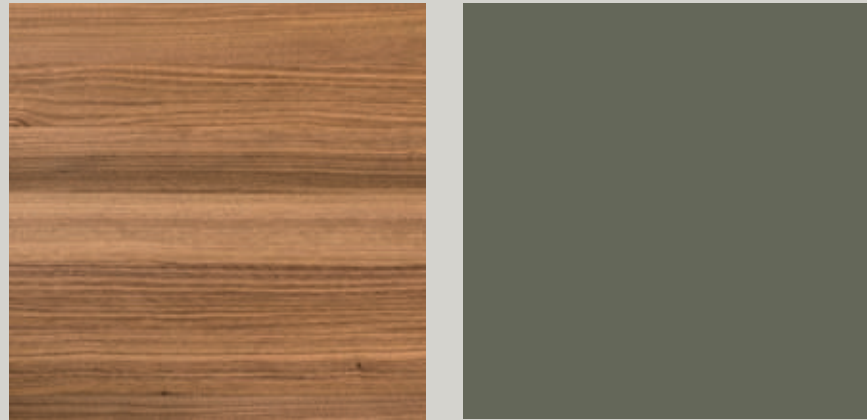
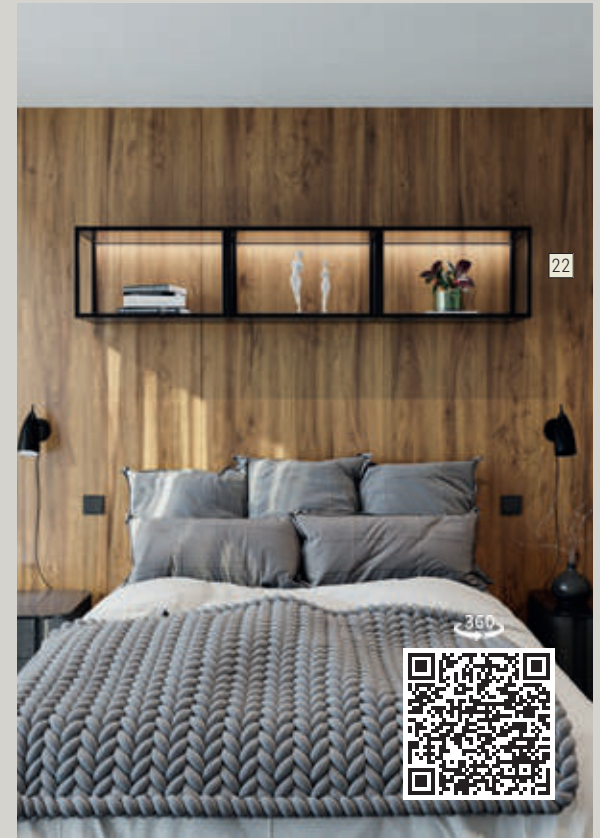
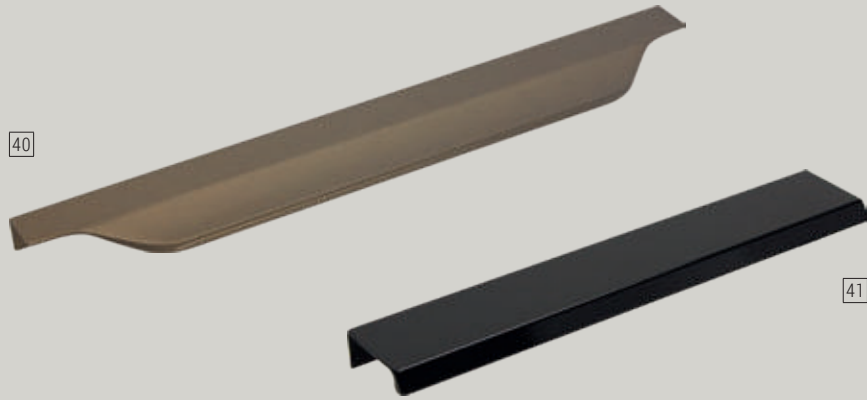

22. STELAŻ WISZĄCY/HANGING FRAME SR44-600-360-L2 / 24. NOGA STALOWA/STEEL LEG NS45-120-L2 / 35. GA32-L36 / 38. KARIA DH31-26J-G7-KW-PR / 39. PLT26-WC-G7-KW-PR / 40. UA119-256-A33-296-19-C / 41. UA123-128-L36-168 / 42. UA130-352-A0 / 43. UA130-352-L36 / 44. US10-1792-L36-F10-Y0 / 45. US10-192-R16 / 46. US10-320-L36

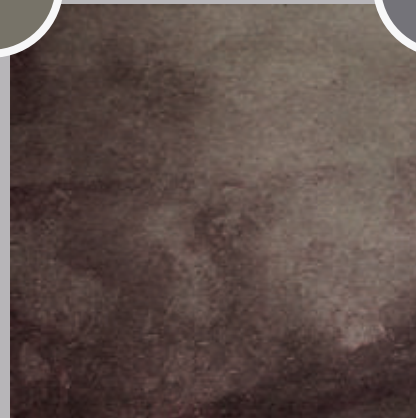
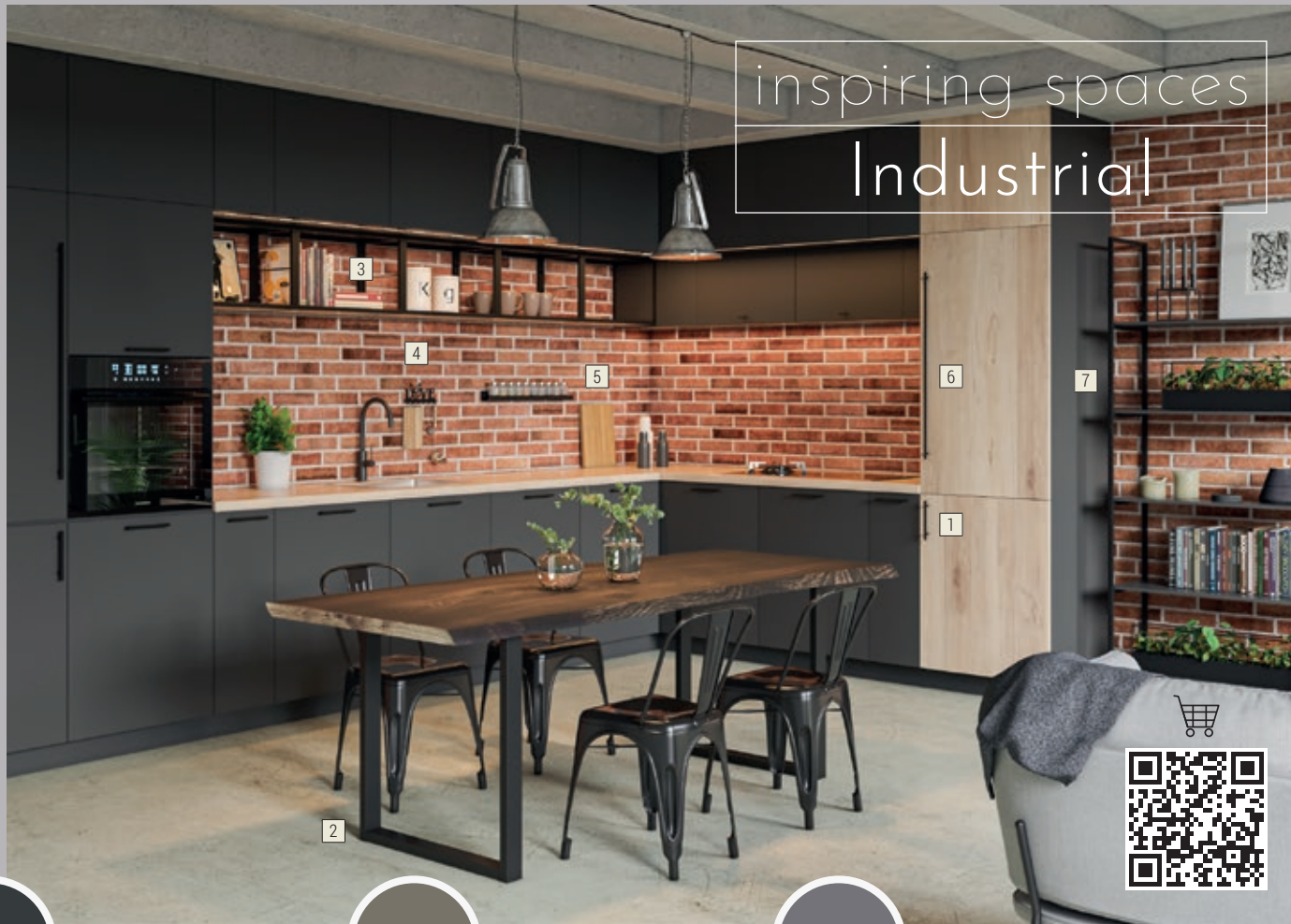

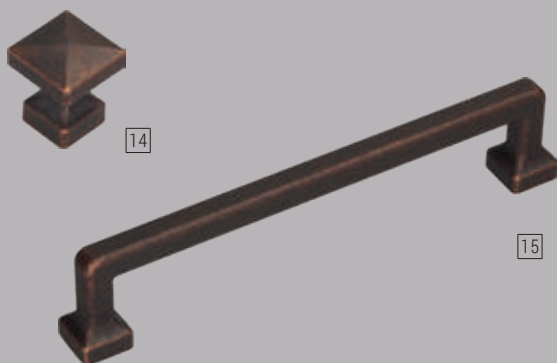

PL: Styl **INDUSTRIAL** uzewnętrznia prawdziwy klimat ciężkiego, surowego, industrialnego wnętrza. Originalny efekt wizualny tworzą: cegła, beton, ciemne drewno i metal, zwłaszcza w wersji postarzonej z imitacją rdzy. W przestronnych wnętrzach dominują ciemne, stonowane barwy jak: czernie, grafity, brązy i oliwkowe zielenie.

EN: The **INDUSTRIAL** style externalizes the true atmosphere of a heavy, raw, industrial interior. The original visual effect is created by elements such as brick, concrete, dark wood and metal, especially in an aged version with imitation of rust. The spacious interiors are dominated by dark, subdued colours with different shades of black, graphite, brown and olive green.

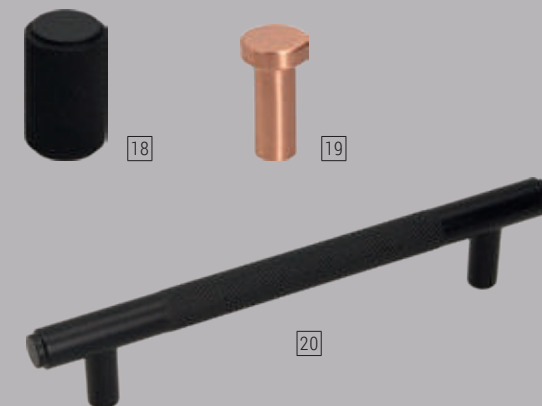
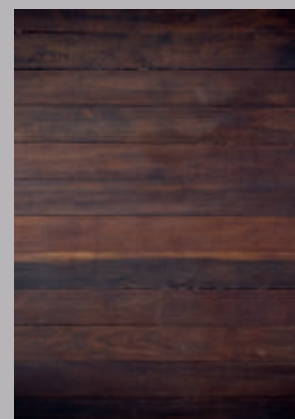



23



24

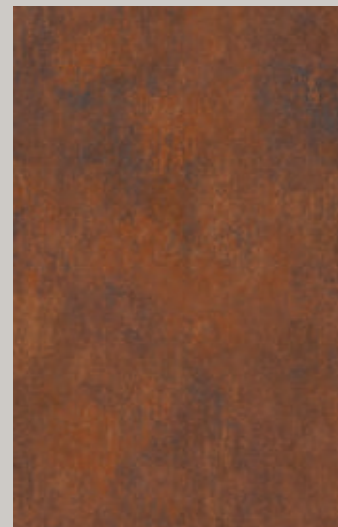

25



26



27

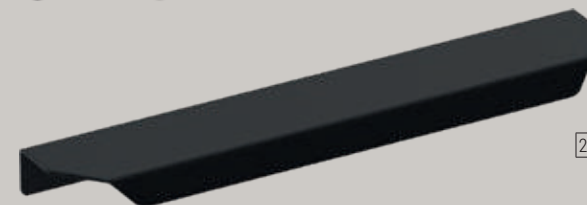

28



29



30





TEENS



inspiring spaces
Teens

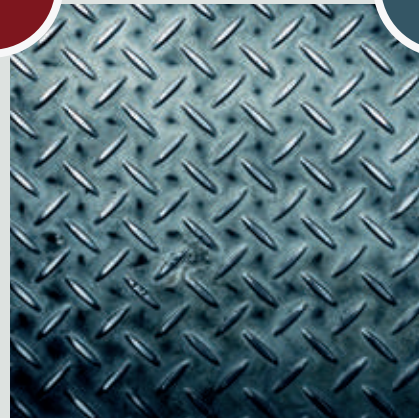

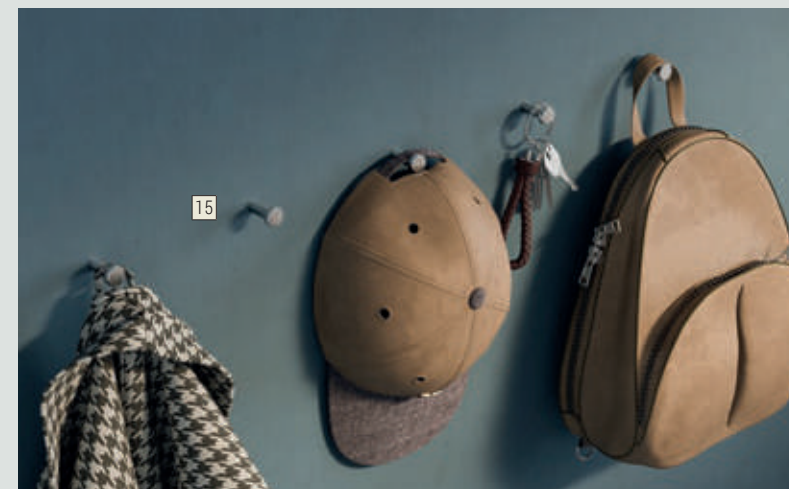

PL: **TEENS** to dobrze zorganizowana przestrzeń dla współczesnych nastolatków. Musi ona spełniać wiele praktycznych funkcji, być wygodna i przyjazna na co dzień. Istotną jest tutaj estetyka, która pomaga nastolatki wyrazić swoją osobowość. Ważną rolę odgrywają także oryginalne dodatki wyposażenia wnętrz i hobbyistyczne akcesoria.

EN: The **TEENS** style is a well-organized space for modern teenagers. It must offer numerous practical functions, be comfortable and welcoming on a day-to-day basis. Aesthetics are of significance here helping teenagers to voice their personality. An important role is also played by genuine interior accessories and hobby items.





19



20



21



22



23



24



25



26



27



28

29

30

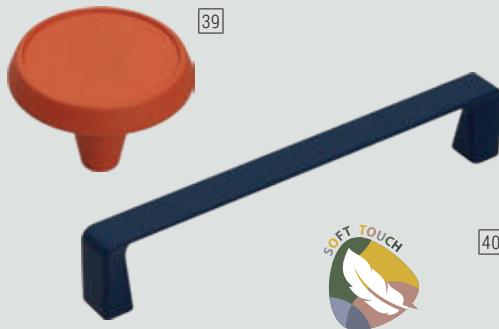

KIDS

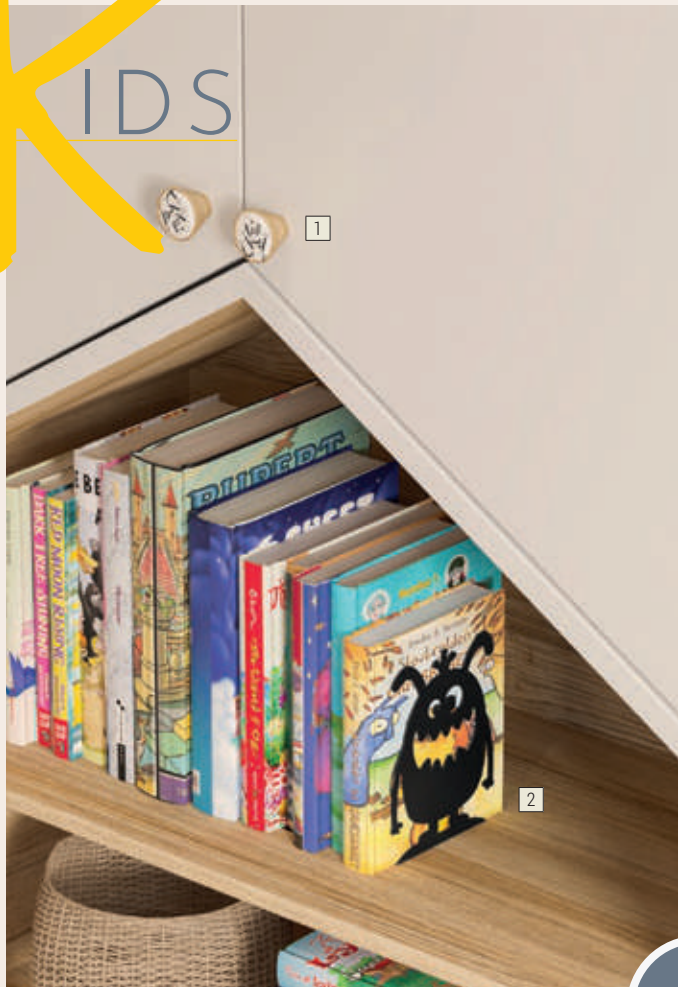

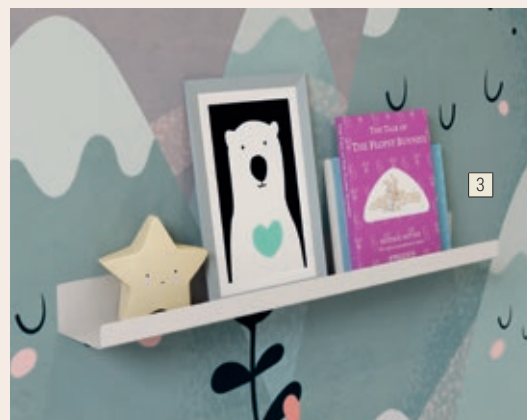

PL: **KIDS** to bezpieczna i pobudzająca wyobraźnię przestrzeń dla milusińskich. Pomieszczenie powinno być przejrzyste, przepelnione światłem i pastelowymi barwami. Kolorowe dodatki, unikalne tapety i miękkie tkaniny tworzą wnętrze, które jest przytulne i pełne dziecięcej kreatywności.

EN: The **KIDS** style is a safe and imagination-stimulating space for children. The room should be unambiguous, filled with light and pastel colours. Colourful accessories, unique wallpapers and soft fabrics make up an interior that is cosy and brimming with childish creativity.

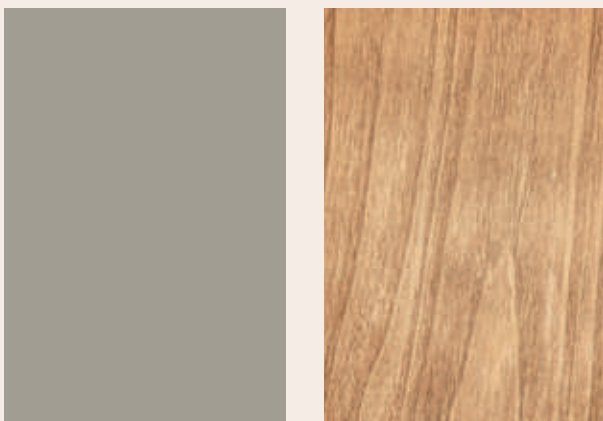

KIDS



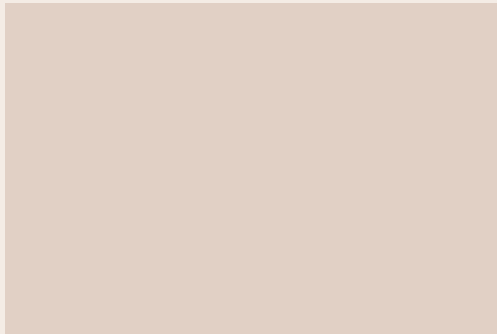

GAMET S.A.
ul. Chrzanowskiego 33
87-100 Toruń, Poland

Biuro Obsługi Klienta / Customer Service Office

PL +48 56 646 22 00
EN +48 56 611 01 80
RU +48 56 611 01 75
DE +48 56 611 01 57
gamet@gamet.eu

GAMET ESPAÑA, S.L.U.
C/ Quinsa, 23
Pol. Ind. Moncada III
46113 Moncada (Valencia), Spain

t. +34 961 489 083
m. +34 683 566 539
gamet@gamet.es



gamet_sa



Gamet.eu



e-katalogi
e-catalogues



pliki 3D
3D files



sklep.gamet.eu

